

12 11 10 9 8 7 6 5 4 3 2 1

H

G

F

E

D

C

B

A

H

G

F

E

D

C

B

A

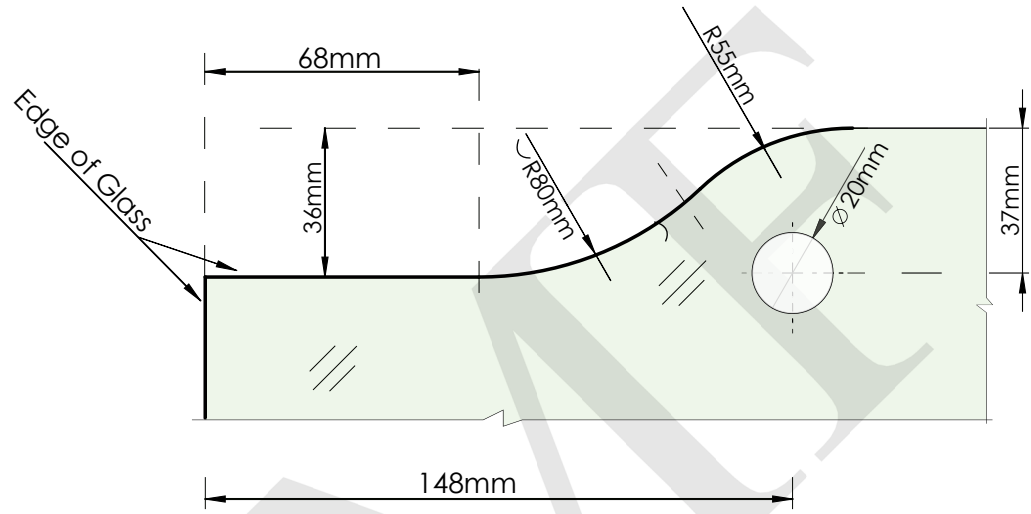

**GLASS FABRICATION**

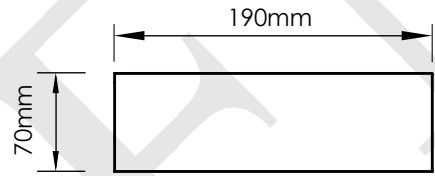

**ELEVATION**

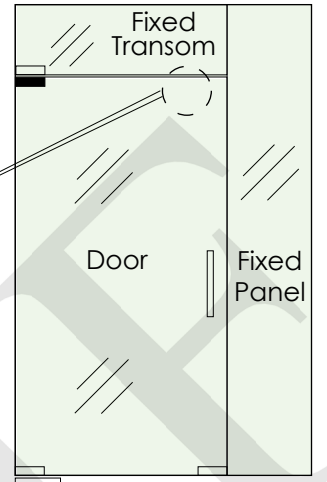
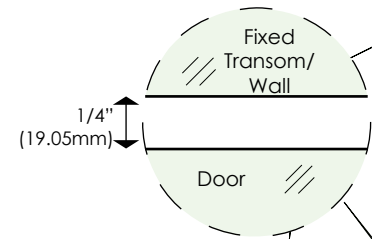
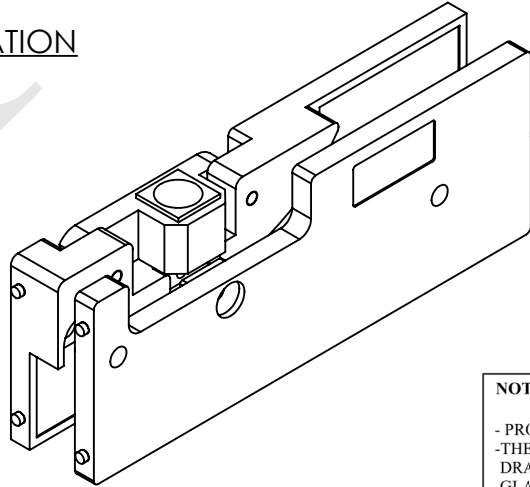

**PAT-02**

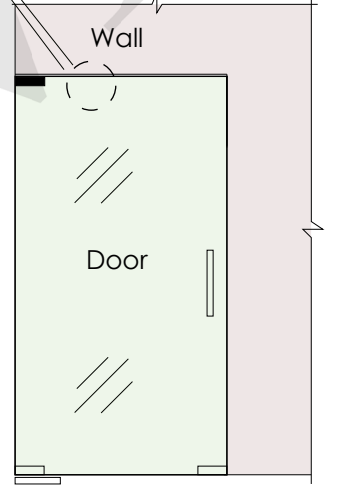
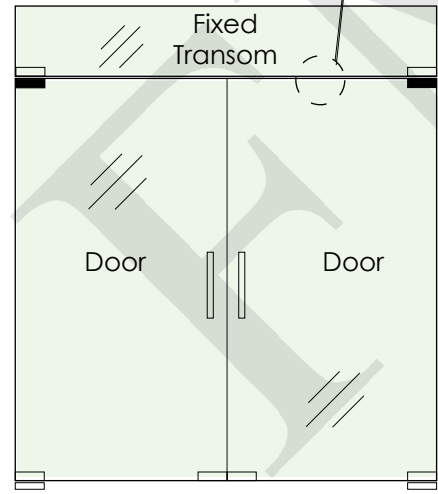

**NOTES:**  
 - PROPRIETARY AND CONFIDENTIAL  
 - THE INFORMATION CONTAINED IN THIS DRAWING IS THE SOLE PROPERTY OF FMF GLASS HARDWARE. ANY REPRODUCTION IN PART OR AS A WHOLE WITHOUT THE WRITTEN PERMISSION OF FMF GLASS HARDWARE IS PROHIBITED.

PRODUCT NAME:  
**Patch fitting -Prima**

PRODUCT MODEL NUMBER:  
**PAT-07**

DWG NO.  
**PAT-07\_1**  
 DATE:  
**10.23**

UNIT:  
**MM**  
 DRAWN BY:  
**FMF**

DWG SIZE/SCALE  
**A4/NTS**

**FMF GLASS HARDWARE**

REV. **1**  
 SHEET **1** OF **1**

12 11 10 9 8 7 6 5 4 3 2 1